

SWITCHMODE™ NPN Silicon Planar Power Transistor

The BUH50 has an application specific state-of-art die designed for use in 50 Watts HALOGEN electronic transformers and SWITCHMODE applications.

This high voltage/high speed transistor exhibits the following main feature:

- Improved Efficiency Due to Low Base Drive Requirements:
High and Flat DC Current Gain h_{FE}
Fast Switching
- ON Semiconductor Six Sigma Philosophy Provides Tight and Reproducible Parametric Distributions
- Specified Dynamic Saturation Data
- Full Characterization at 125°C

MAXIMUM RATINGS

Rating	Symbol	Value	Unit
Collector–Emitter Sustaining Voltage	V_{CEO}	500	Vdc
Collector–Base Breakdown Voltage	V_{CB0}	800	Vdc
Collector–Emitter Breakdown Voltage	V_{CES}	800	Vdc
Emitter–Base Voltage	V_{EBO}	9	Vdc
Collector Current — Continuous — Peak (1)	I_C I_{CM}	4 8	Adc
Base Current — Continuous — Peak (1)	I_B I_{BM}	2 4	Adc
*Total Device Dissipation @ $T_C = 25^\circ\text{C}$ *Derate above 25°C	P_D	50 0.4	Watt W/°C
Operating and Storage Temperature	T_J, T_{stg}	-65 to 150	°C

THERMAL CHARACTERISTICS

Thermal Resistance — Junction to Case — Junction to Ambient	$R_{\theta JC}$ $R_{\theta JA}$	2.5 62.5	°C/W
Maximum Lead Temperature for Soldering Purposes: 1/8" from case for 5 seconds	T_L	260	°C

(1) Pulse Test: Pulse Width = 5 ms, Duty Cycle ≤ 10%.

BUH50

POWER TRANSISTOR
4 AMPERES
800 VOLTS
50 WATTS

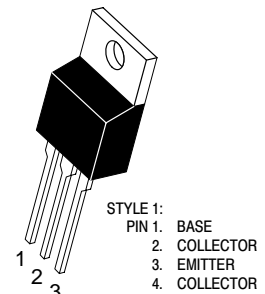
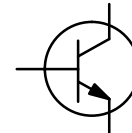

CASE 221A-09
TO-220AB

BUH50

ELECTRICAL CHARACTERISTICS ($T_C = 25^\circ\text{C}$ unless otherwise noted)

Characteristic	Symbol	Min	Typ	Max	Unit
OFF CHARACTERISTICS					
Collector–Emitter Sustaining Voltage ($I_C = 100\text{ mA}$, $L = 25\text{ mH}$)	$V_{CEO(sus)}$	500			Vdc
Collector Cutoff Current ($V_{CE} = \text{Rated } V_{CEO}$, $I_B = 0$)	I_{CEO}			100	μAdc
Collector Cutoff Current ($V_{CE} = \text{Rated } V_{CES}$, $V_{EB} = 0$)	I_{CES}			100 1000	μAdc
Emitter–Cutoff Current ($V_{EB} = 9\text{ Vdc}$, $I_C = 0$)	I_{EBO}			100	μAdc

ON CHARACTERISTICS

Base–Emitter Saturation Voltage ($I_C = 1\text{ Adc}$, $I_B = 0.33\text{ Adc}$) ($I_C = 2\text{ Adc}$, $I_B = 0.66\text{ Adc}$) 25°C ($I_C = 2\text{ Adc}$, $I_B = 0.66\text{ Adc}$) 100°C	$V_{BE(sat)}$		0.86 0.94 0.85	1.2 1.6 1.5	Vdc
Collector–Emitter Saturation Voltage ($I_C = 1\text{ Adc}$, $I_B = 0.33\text{ Adc}$) ($I_C = 2\text{ Adc}$, $I_B = 0.66\text{ Adc}$) ($I_C = 3\text{ Adc}$, $I_B = 1\text{ Adc}$)	$V_{CE(sat)}$	@ $T_C = 25^\circ\text{C}$ @ $T_C = 25^\circ\text{C}$ @ $T_C = 125^\circ\text{C}$ @ $T_C = 25^\circ\text{C}$	0.2 0.32 0.29 0.5	0.5 0.6 0.7 1	Vdc
DC Current Gain ($I_C = 1\text{ Adc}$, $V_{CE} = 5\text{ Vdc}$) ($I_C = 2\text{ Adc}$, $V_{CE} = 5\text{ Vdc}$)	h_{FE}	@ $T_C = 25^\circ\text{C}$ @ $T_C = 25^\circ\text{C}$	7 5	13 10	— —

DYNAMIC CHARACTERISTICS

Current Gain Bandwidth ($I_C = 0.5\text{ Adc}$, $V_{CE} = 10\text{ Vdc}$, $f = 1\text{ MHz}$)	f_T	4			MHz
Output Capacitance ($V_{CB} = 10\text{ Vdc}$, $I_E = 0$, $f = 1\text{ MHz}$)	C_{ob}		50	100	pF
Input Capacitance ($V_{EB} = 8\text{ Vdc}$)	C_{ib}		850	1200	pF

DYNAMIC SATURATION VOLTAGE

Dynamic Saturation Voltage: Determined $1\ \mu\text{s}$ and $3\ \mu\text{s}$ respectively after rising I_{B1} reaches 90% of final I_{B1}	$I_C = 1\text{ A}$ $I_{B1} = 0.33\text{ A}$ $V_{CC} = 300\text{ V}$	@ $1\ \mu\text{s}$	@ $T_C = 25^\circ\text{C}$ @ $T_C = 125^\circ\text{C}$	$V_{CE(dsat)}$	1.75 5		V
		@ $3\ \mu\text{s}$	@ $T_C = 25^\circ\text{C}$ @ $T_C = 125^\circ\text{C}$		0.3 0.5		V
	$I_C = 2\text{ A}$ $I_{B1} = 0.66\text{ A}$ $V_{CC} = 300\text{ V}$	@ $1\ \mu\text{s}$	@ $T_C = 25^\circ\text{C}$ @ $T_C = 125^\circ\text{C}$	6 14		V	
		@ $3\ \mu\text{s}$	@ $T_C = 25^\circ\text{C}$ @ $T_C = 125^\circ\text{C}$	0.75 4		V	

BUH50

ELECTRICAL CHARACTERISTICS ($T_C = 25^\circ\text{C}$ unless otherwise noted)

Characteristic	Symbol	Min	Typ	Max	Unit
----------------	--------	-----	-----	-----	------

SWITCHING CHARACTERISTICS: Resistive Load (D.C. $\leq 10\%$, Pulse Width = 20 μs)

Turn-on Time	$I_C = 2 \text{ Adc}$, $I_{B1} = 0.4 \text{ Adc}$ $I_{B2} = 0.4 \text{ Adc}$ $V_{CC} = 125 \text{ Vdc}$	@ $T_C = 25^\circ\text{C}$	t_{on}	95	250	ns
Turn-off Time		@ $T_C = 25^\circ\text{C}$	t_{off}	2.5	3.5	μs
Turn-on Time	$I_C = 2 \text{ Adc}$, $I_{B1} = 0.4 \text{ Adc}$ $I_{B2} = 1 \text{ Adc}$ $V_{CC} = 125 \text{ Vdc}$	@ $T_C = 25^\circ\text{C}$	t_{on}	110	250	ns
Turn-off Time		@ $T_C = 25^\circ\text{C}$	t_{off}	0.95	2	μs
Turn-on Time	$I_C = 1 \text{ Adc}$, $I_{B1} = 0.3 \text{ Adc}$ $I_{B2} = 0.3 \text{ Adc}$ $V_{CC} = 125 \text{ Vdc}$	@ $T_C = 25^\circ\text{C}$	t_{on}	100	200	ns
Turn-off Time		@ $T_C = 25^\circ\text{C}$	t_{off}	2.9	3.5	μs

SWITCHING CHARACTERISTICS: Inductive Load ($V_{clamp} = 300 \text{ V}$, $V_{CC} = 15 \text{ V}$, $L = 200 \mu\text{H}$)

Fall Time	$I_C = 2 \text{ Adc}$ $I_{B1} = 0.4 \text{ Adc}$ $I_{B2} = 1 \text{ Adc}$	@ $T_C = 25^\circ\text{C}$	t_f	80	150	ns
		@ $T_C = 125^\circ\text{C}$		95		
Storage Time		@ $T_C = 25^\circ\text{C}$	t_s	1.2	2.5	μs
	@ $T_C = 125^\circ\text{C}$	1.7				
Crossover Time		@ $T_C = 25^\circ\text{C}$	t_c	150	300	ns
		@ $T_C = 125^\circ\text{C}$		180		
Fall Time	$I_C = 2 \text{ Adc}$ $I_{B1} = 0.66 \text{ Adc}$ $I_{B2} = 1 \text{ Adc}$	@ $T_C = 25^\circ\text{C}$	t_f	90	150	ns
		@ $T_C = 125^\circ\text{C}$		100		
Storage Time		@ $T_C = 25^\circ\text{C}$	t_s	1.7	2.75	μs
	@ $T_C = 125^\circ\text{C}$	2.5				
Crossover Time		@ $T_C = 25^\circ\text{C}$	t_c	190	350	ns
		@ $T_C = 125^\circ\text{C}$		220		

TYPICAL STATIC CHARACTERISTICS

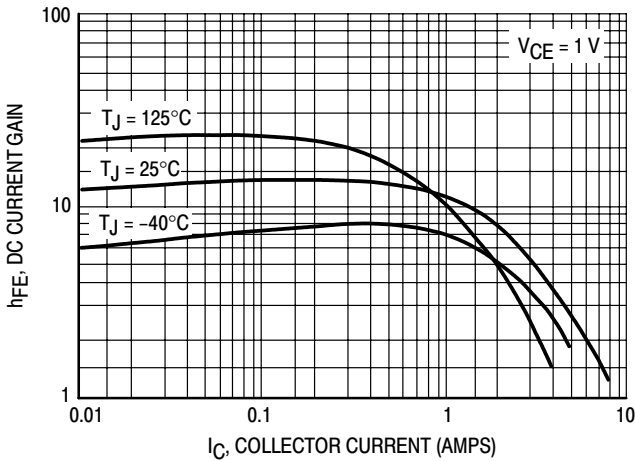

Figure 1. DC Current Gain @ 1 Volt

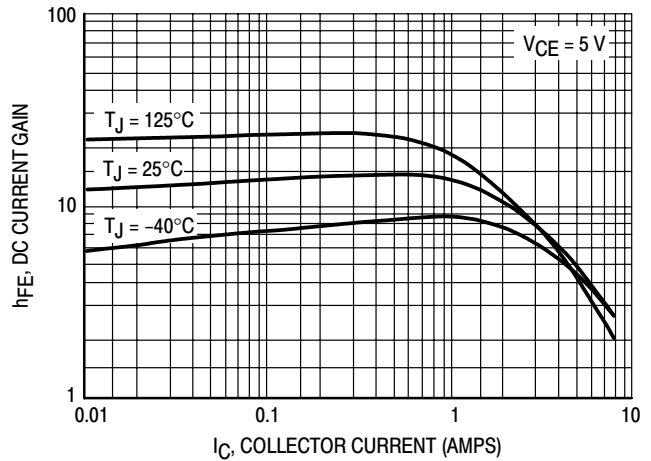

Figure 2. DC Current Gain @ 5 Volt

BUH50

TYPICAL STATIC CHARACTERISTICS

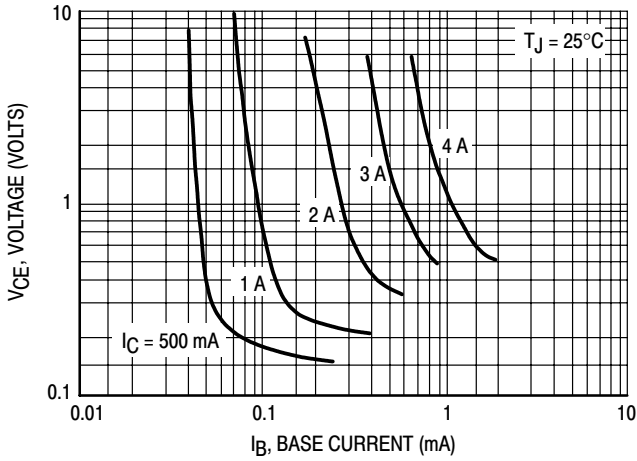

Figure 3. Collector Saturation Region

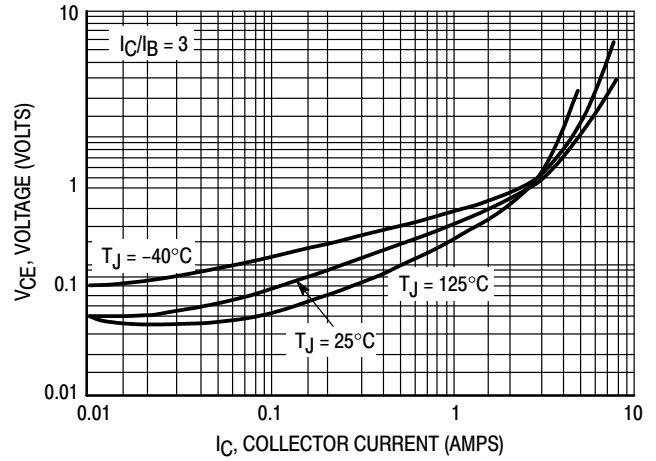

Figure 4. Collector-Emitter Saturation Voltage

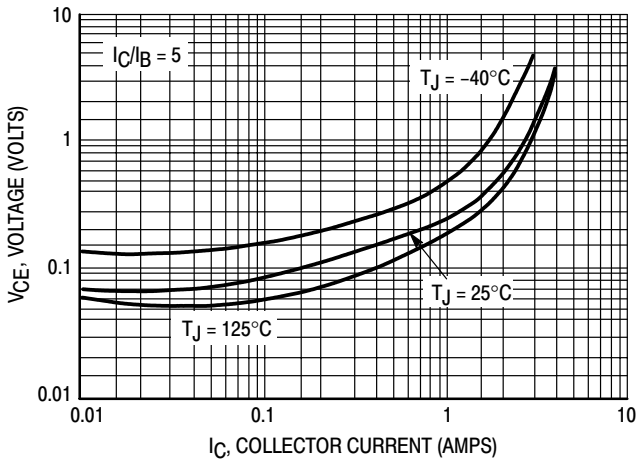

Figure 5. Collector-Emitter Saturation Voltage

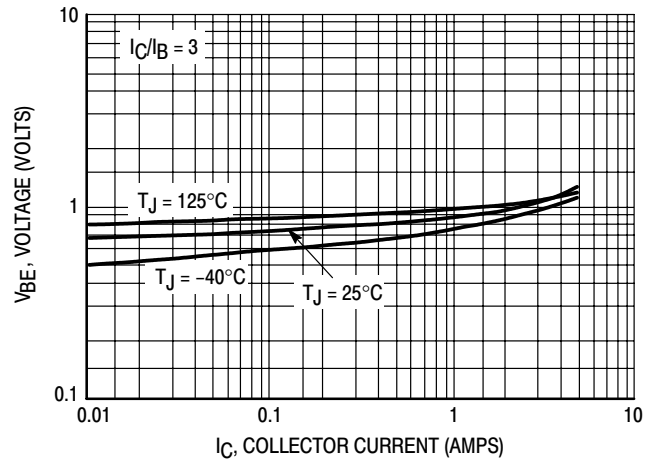

Figure 6. Base-Emitter Saturation Region

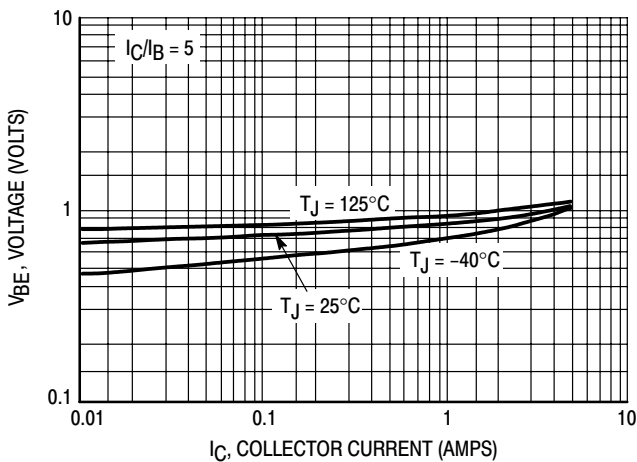

Figure 7. Base-Emitter Saturation Region

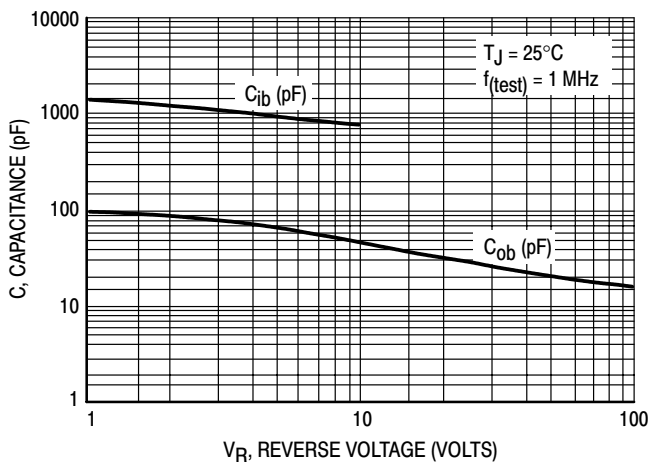

Figure 8. Capacitance

TYPICAL SWITCHING CHARACTERISTICS

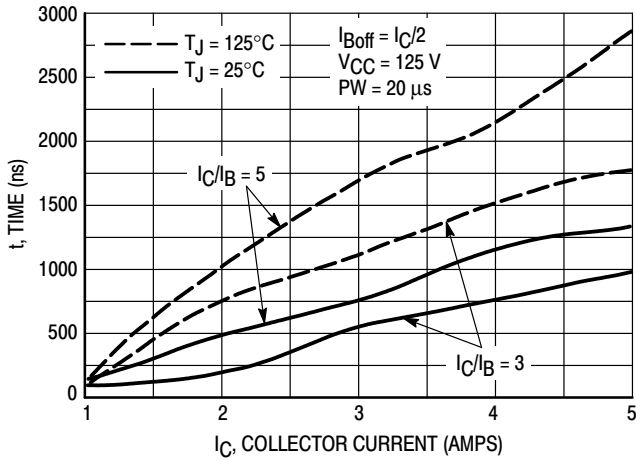

Figure 9. Resistive Switching, t_{on}

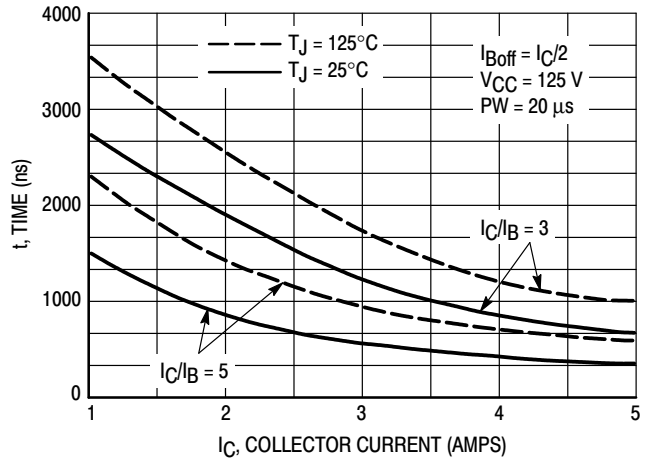

Figure 10. Resistive Switch Time, t_{off}

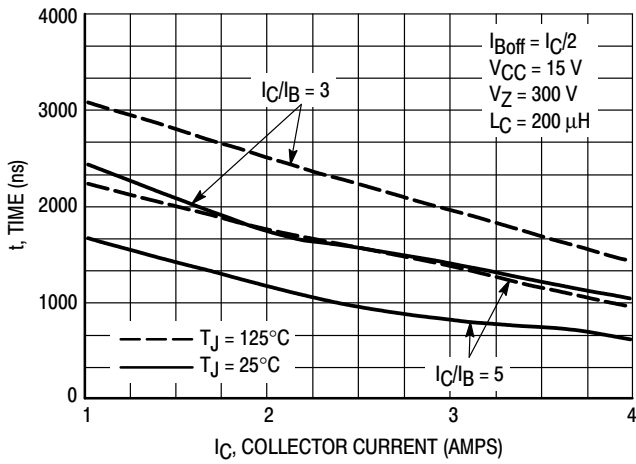

Figure 11. Inductive Storage Time, t_{sj}

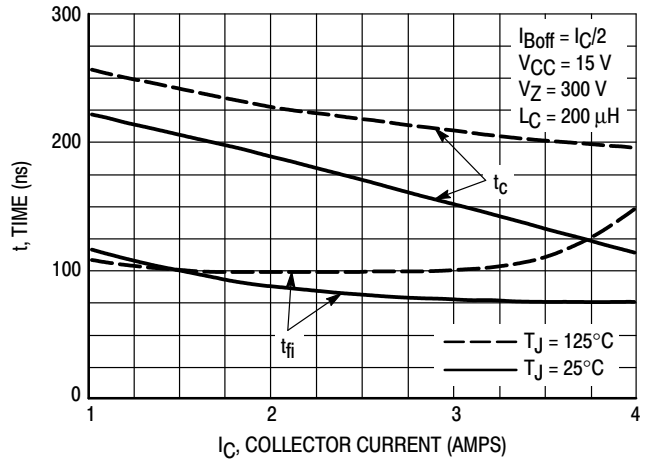

Figure 12. Inductive Storage Time, t_c & t_{fi} @ $I_C/I_B = 3$

TYPICAL CHARACTERISTICS

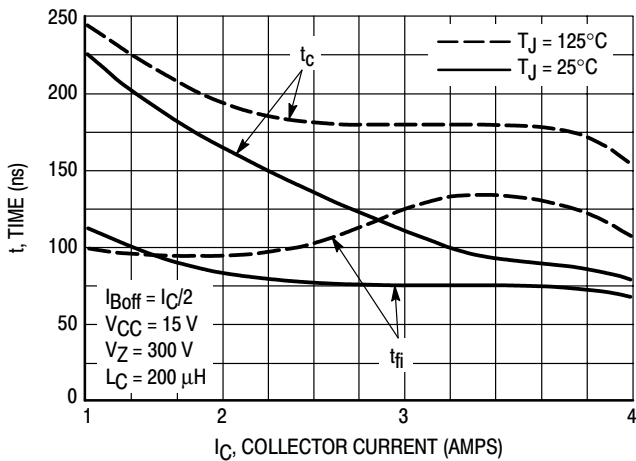

Figure 13. Inductive Switching, t_c & t_{fi} @ $I_C/I_B = 5$

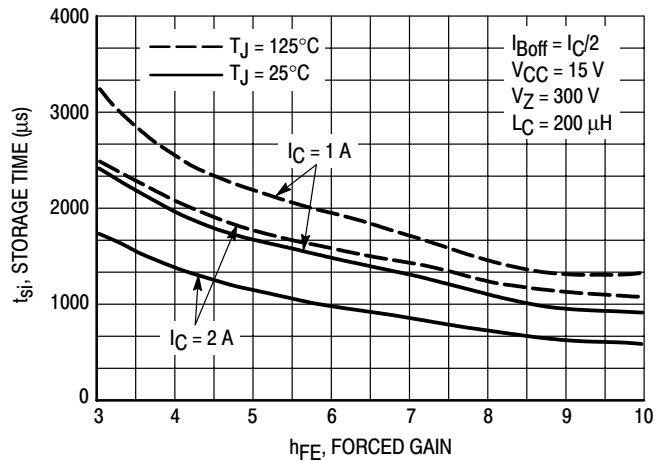

Figure 14. Inductive Storage Time

BUH50

TYPICAL CHARACTERISTICS

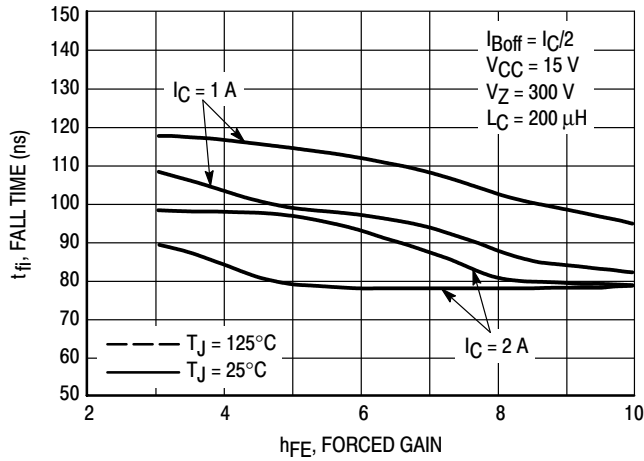

Figure 15. Inductive Fall Time

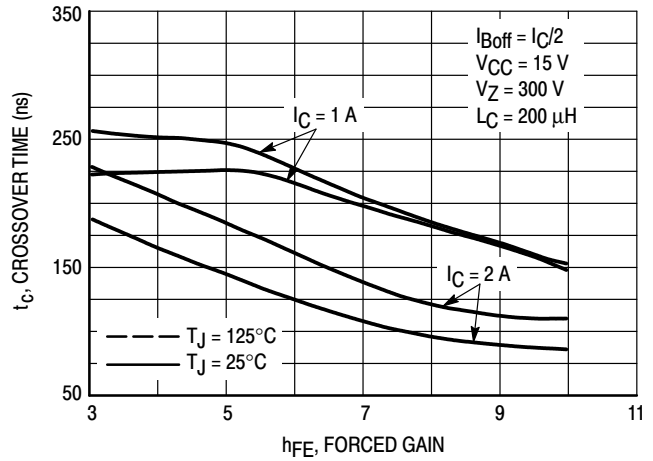

Figure 16. Inductive Crossover Time

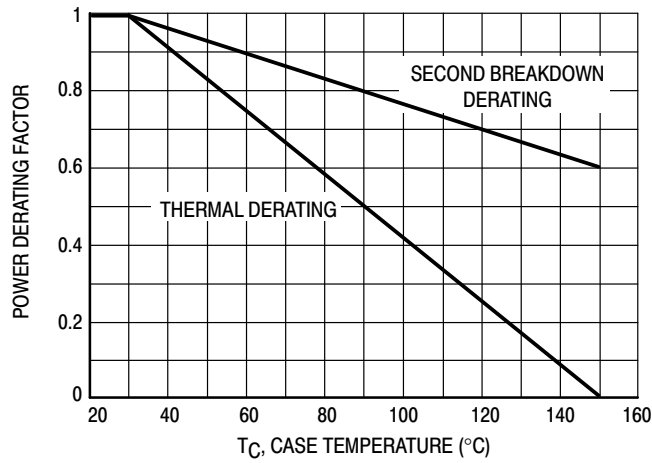

Figure 17. Forward Power Derating

There are two limitations on the power handling ability of a transistor: average junction temperature and second breakdown. Safe operating area curves indicate I_C - V_{CE} limits of the transistor that must be observed for reliable operation; i.e., the transistor must not be subjected to greater dissipation than the curves indicate. The data of Figure 20 is based on $T_C = 25^\circ\text{C}$; $T_{J(pk)}$ is variable depending on power level. Second breakdown pulse limits are valid for duty cycles to 10% but must be derated when $T_C > 25^\circ\text{C}$. Second breakdown limitations do not derate the same as thermal limitations. Allowable current at the voltages shown on Figure 20 may be found at any case temperature by using the appropriate curve on Figure 17.

$T_{J(pk)}$ may be calculated from the data in Figure 22. At any case temperatures, thermal limitations will reduce the power that can be handled to values less than the limitations imposed by second breakdown. For inductive loads, high voltage and current must be sustained simultaneously during turn-off with the base to emitter junction reverse biased. The safe level is specified as a reverse biased safe operating area (Figure 21). This rating is verified under clamped conditions so that the device is never subjected to an avalanche mode.

TYPICAL CHARACTERISTICS

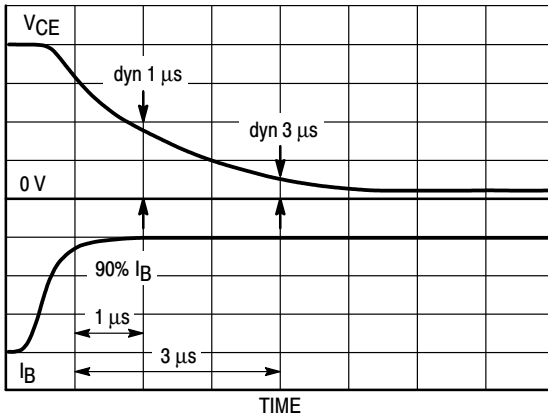

Figure 18. Dynamic Saturation Voltage

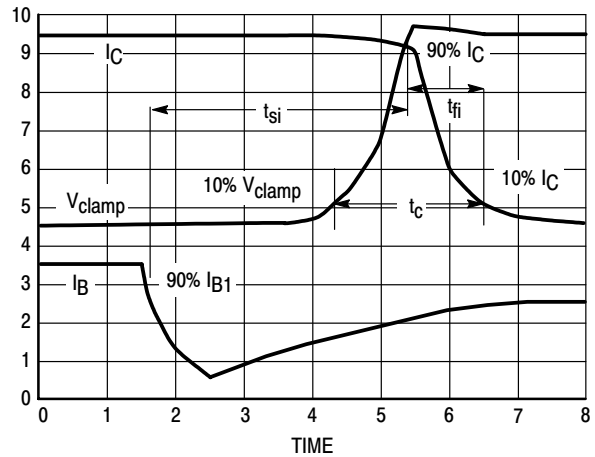

Figure 19. Inductive Switching Measurements

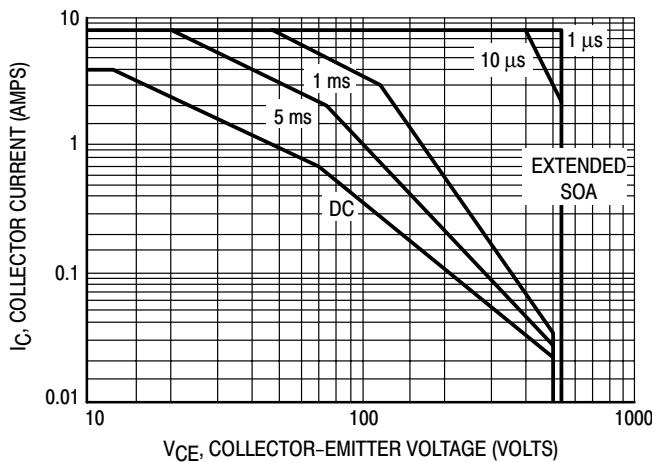

Figure 20. Forward Bias Safe Operating Area

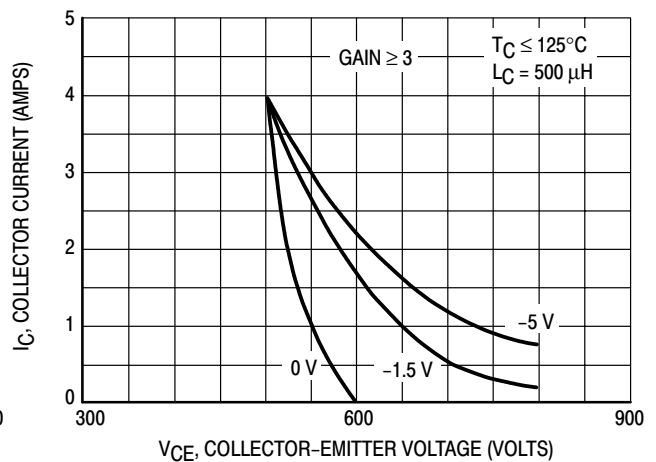
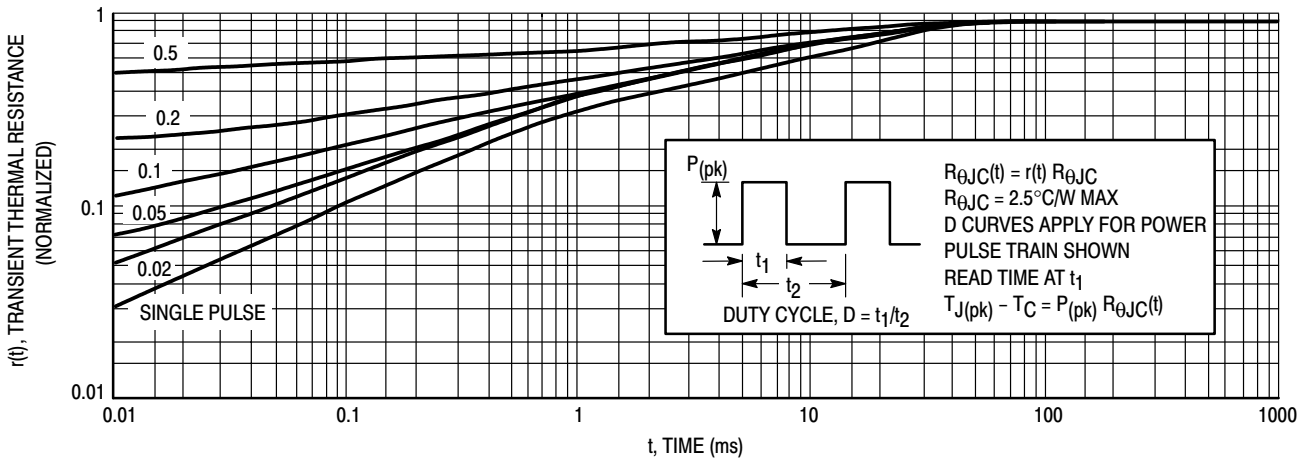
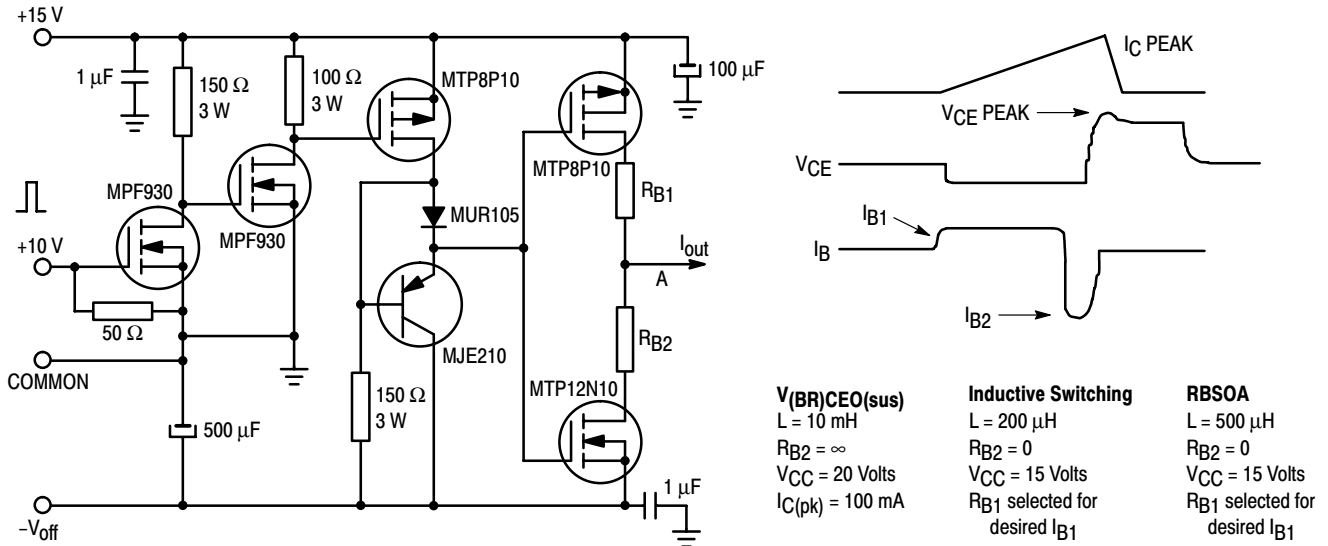

Figure 21. Reverse Bias Safe Operating Area

BUH50

TYPICAL CHARACTERISTICS

Table 1. Inductive Load Switching Drive Circuit



BUH50

PACKAGE DIMENSIONS

TO-220AB CASE 221A-09 ISSUE AA

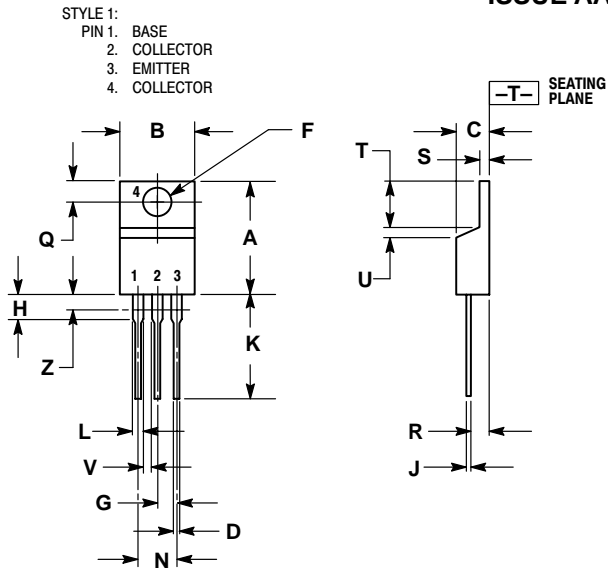

- NOTES:
1. DIMENSIONING AND TOLERANCING PER ANSI Y14.5M, 1982.
 2. CONTROLLING DIMENSION: INCH.
 3. DIMENSION Z DEFINES A ZONE WHERE ALL BODY AND LEAD IRREGULARITIES ARE ALLOWED.

DIM	INCHES		MILLIMETERS	
	MIN	MAX	MIN	MAX
A	0.570	0.620	14.48	15.75
B	0.380	0.405	9.66	10.28
C	0.160	0.190	4.07	4.82
D	0.025	0.035	0.64	0.88
F	0.142	0.147	3.61	3.73
G	0.095	0.105	2.42	2.66
H	0.110	0.155	2.80	3.93
J	0.018	0.025	0.46	0.64
K	0.500	0.562	12.70	14.27
L	0.045	0.060	1.15	1.52
N	0.190	0.210	4.83	5.33
Q	0.100	0.120	2.54	3.04
R	0.080	0.110	2.04	2.79
S	0.045	0.055	1.15	1.39
T	0.235	0.255	5.97	6.47
U	0.000	0.050	0.00	1.27
V	0.045	---	1.15	---
Z	---	0.080	---	2.04

Notes

Notes

SENFET is a trademark of Semiconductor Components Industries, LLC.

ON Semiconductor and  are registered trademarks of Semiconductor Components Industries, LLC (SCILLC). SCILLC reserves the right to make changes without further notice to any products herein. SCILLC makes no warranty, representation or guarantee regarding the suitability of its products for any particular purpose, nor does SCILLC assume any liability arising out of the application or use of any product or circuit, and specifically disclaims any and all liability, including without limitation special, consequential or incidental damages. "Typical" parameters which may be provided in SCILLC data sheets and/or specifications can and do vary in different applications and actual performance may vary over time. All operating parameters, including "Typicals" must be validated for each customer application by customer's technical experts. SCILLC does not convey any license under its patent rights nor the rights of others. SCILLC products are not designed, intended, or authorized for use as components in systems intended for surgical implant into the body, or other applications intended to support or sustain life, or for any other application in which the failure of the SCILLC product could create a situation where personal injury or death may occur. Should Buyer purchase or use SCILLC products for any such unintended or unauthorized application, Buyer shall indemnify and hold SCILLC and its officers, employees, subsidiaries, affiliates, and distributors harmless against all claims, costs, damages, and expenses, and reasonable attorney fees arising out of, directly or indirectly, any claim of personal injury or death associated with such unintended or unauthorized use, even if such claim alleges that SCILLC was negligent regarding the design or manufacture of the part. SCILLC is an Equal Opportunity/Affirmative Action Employer.

PUBLICATION ORDERING INFORMATION

Literature Fulfillment:

Literature Distribution Center for ON Semiconductor
P.O. Box 5163, Denver, Colorado 80217 USA
Phone: 303-675-2175 or 800-344-3860 Toll Free USA/Canada
Fax: 303-675-2176 or 800-344-3867 Toll Free USA/Canada
Email: ONlit@hibbertco.com

N. American Technical Support: 800-282-9855 Toll Free USA/Canada

JAPAN: ON Semiconductor, Japan Customer Focus Center
4-32-1 Nishi-Gotanda, Shinagawa-ku, Tokyo, Japan 141-0031
Phone: 81-3-5740-2700
Email: r14525@onsemi.com

ON Semiconductor Website: <http://onsemi.com>

For additional information, please contact your local Sales Representative.